

*Single switch  
with Series diode  
MOSFET Power Module*

**$V_{DSS} = 1000V$**   
 **$R_{DSon} = 45m\Omega$  typ @  $T_j = 25^\circ C$**   
 **$I_D = 215A$  @  $T_c = 25^\circ C$**

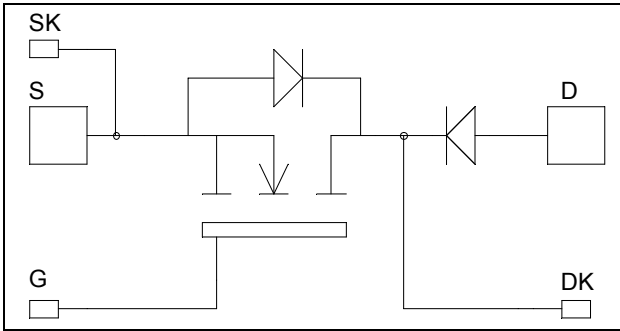

#### Application

- Zero Current Switching resonant mode

#### Features

- Power MOS 7<sup>®</sup> MOSFETs
  - Low  $R_{DSon}$
  - Low input and Miller capacitance
  - Low gate charge
  - Avalanche energy rated
  - Very rugged
- Kelvin source for easy drive
- Very low stray inductance
  - Symmetrical design
  - M5 power connectors
- High level of integration
- AlN substrate for improved thermal performance

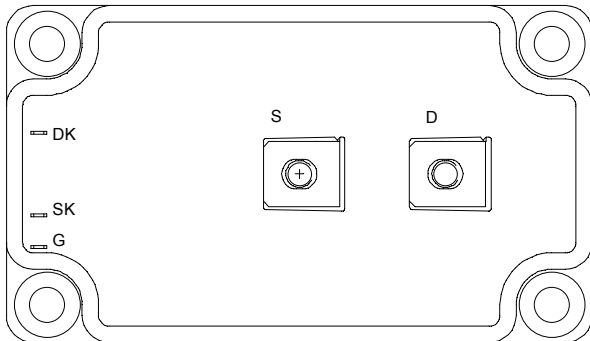

#### Benefits

- Outstanding performance at high frequency operation
- Direct mounting to heatsink (isolated package)
- Low junction to case thermal resistance
- Low profile
- RoHS Compliant

### Absolute maximum ratings

Symbol	Parameter	Max ratings	Unit
$V_{DSS}$	Drain - Source Breakdown Voltage	1000	V
$I_D$	Continuous Drain Current	$T_c = 25^\circ C$	215
		$T_c = 80^\circ C$	160
$I_{DM}$	Pulsed Drain current	860	A
$V_{GS}$	Gate - Source Voltage	$\pm 30$	V
$R_{DSon}$	Drain - Source ON Resistance	52	$m\Omega$
$P_D$	Maximum Power Dissipation	$T_c = 25^\circ C$	5000
$I_{AR}$	Avalanche current (repetitive and non repetitive)	30	A
$E_{AR}$	Repetitive Avalanche Energy	50	mJ
$E_{AS}$	Single Pulse Avalanche Energy	3200	

**CAUTION:** These Devices are sensitive to Electrostatic Discharge. Proper Handling Procedures Should Be Followed. See application note APT0502 on [www.microsemi.com](http://www.microsemi.com)

All ratings @  $T_j = 25^\circ\text{C}$  unless otherwise specified

**Electrical Characteristics**

Symbol	Characteristic	Test Conditions	Min	Typ	Max	Unit
$I_{DSS}$	Zero Gate Voltage Drain Current	$V_{GS} = 0V, V_{DS} = 1000V$   $T_j = 25^\circ\text{C}$			600	$\mu\text{A}$
		$V_{GS} = 0V, V_{DS} = 800V$   $T_j = 125^\circ\text{C}$			3	$\text{mA}$
$R_{DS(on)}$	Drain – Source on Resistance	$V_{GS} = 10V, I_D = 107.5A$		45	52	$\text{m}\Omega$
$V_{GS(th)}$	Gate Threshold Voltage	$V_{GS} = V_{DS}, I_D = 30\text{mA}$	3		5	V
$I_{GSS}$	Gate – Source Leakage Current	$V_{GS} = \pm 30V, V_{DS} = 0V$			$\pm 600$	$\text{nA}$

**Dynamic Characteristics**

Symbol	Characteristic	Test Conditions	Min	Typ	Max	Unit
$C_{iss}$	Input Capacitance	$V_{GS} = 0V$ $V_{DS} = 25V$ $f = 1\text{MHz}$		42.7		$\text{nF}$
$C_{oss}$	Output Capacitance			7.6		
$C_{rss}$	Reverse Transfer Capacitance			1.3		
$Q_g$	Total gate Charge	$V_{GS} = 10V$ $V_{Bus} = 500V$ $I_D = 215A$		1602		$\text{nC}$
$Q_{gs}$	Gate – Source Charge			204		
$Q_{gd}$	Gate – Drain Charge			1038		
$T_{d(on)}$	Turn-on Delay Time	<b>Inductive switching @ <math>125^\circ\text{C}</math></b> $V_{GS} = 15V$ $V_{Bus} = 670V$ $I_D = 215A$ $R_G = 0.5\Omega$		18		$\text{ns}$
$T_r$	Rise Time			14		
$T_{d(off)}$	Turn-off Delay Time			140		
$T_f$	Fall Time			55		
$E_{on}$	Turn-on Switching Energy	<b>Inductive switching @ <math>25^\circ\text{C}</math></b> $V_{GS} = 15V, V_{Bus} = 670V$ $I_D = 215A, R_G = 0.5\Omega$		7.2		$\text{mJ}$
$E_{off}$	Turn-off Switching Energy			4.3		
$E_{on}$	Turn-on Switching Energy	<b>Inductive switching @ <math>125^\circ\text{C}</math></b> $V_{GS} = 15V, V_{Bus} = 670V$ $I_D = 215A, R_G = 0.5\Omega$		12		$\text{mJ}$
$E_{off}$	Turn-off Switching Energy			5.8		

**Series diode ratings and characteristics**

Symbol	Characteristic	Test Conditions	Min	Typ	Max	Unit
$V_{RRM}$	Maximum Repetitive Reverse Voltage		1200			V
$I_{RM}$	Maximum Reverse Leakage Current	$V_R = 1200V$	$T_j = 25^\circ\text{C}$		600	$\mu\text{A}$
			$T_j = 125^\circ\text{C}$		2000	
$I_F$	DC Forward Current			360		A
$V_F$	Diode Forward Voltage	$I_F = 360A$		2.5	3	V
		$I_F = 720A$		3		
		$I_F = 360A$   $T_j = 125^\circ\text{C}$		1.8		
$t_{rr}$	Reverse Recovery Time	$I_F = 360A$ $V_R = 800V$ $di/dt = 1200A/\mu\text{s}$	$T_j = 25^\circ\text{C}$		265	$\text{ns}$
			$T_j = 125^\circ\text{C}$		350	
$Q_{rr}$	Reverse Recovery Charge		$T_j = 25^\circ\text{C}$		3.3	$\mu\text{C}$
			$T_j = 125^\circ\text{C}$		17.3	

## Thermal and package characteristics

Symbol	Characteristic	Min	Typ	Max	Unit	
R <sub>thJC</sub>	Junction to Case Thermal Resistance	Transistor		0.025	°C/W	
		Series diode		0.16		
V <sub>ISOL</sub>	RMS Isolation Voltage, any terminal to case t = 1 min, I <sub>isol</sub> < 1mA, 50/60Hz	2500			V	
T <sub>J</sub>	Operating junction temperature range	-40		150	°C	
T <sub>STG</sub>	Storage Temperature Range	-40		125		
T <sub>C</sub>	Operating Case Temperature	-40		100		
Torque	Mounting torque	To Heatsink	M6	3	5	N.m
		For terminals	M5	2	3.5	
Wt	Package Weight			280	g	

## SP6 Package outline (dimensions in mm)

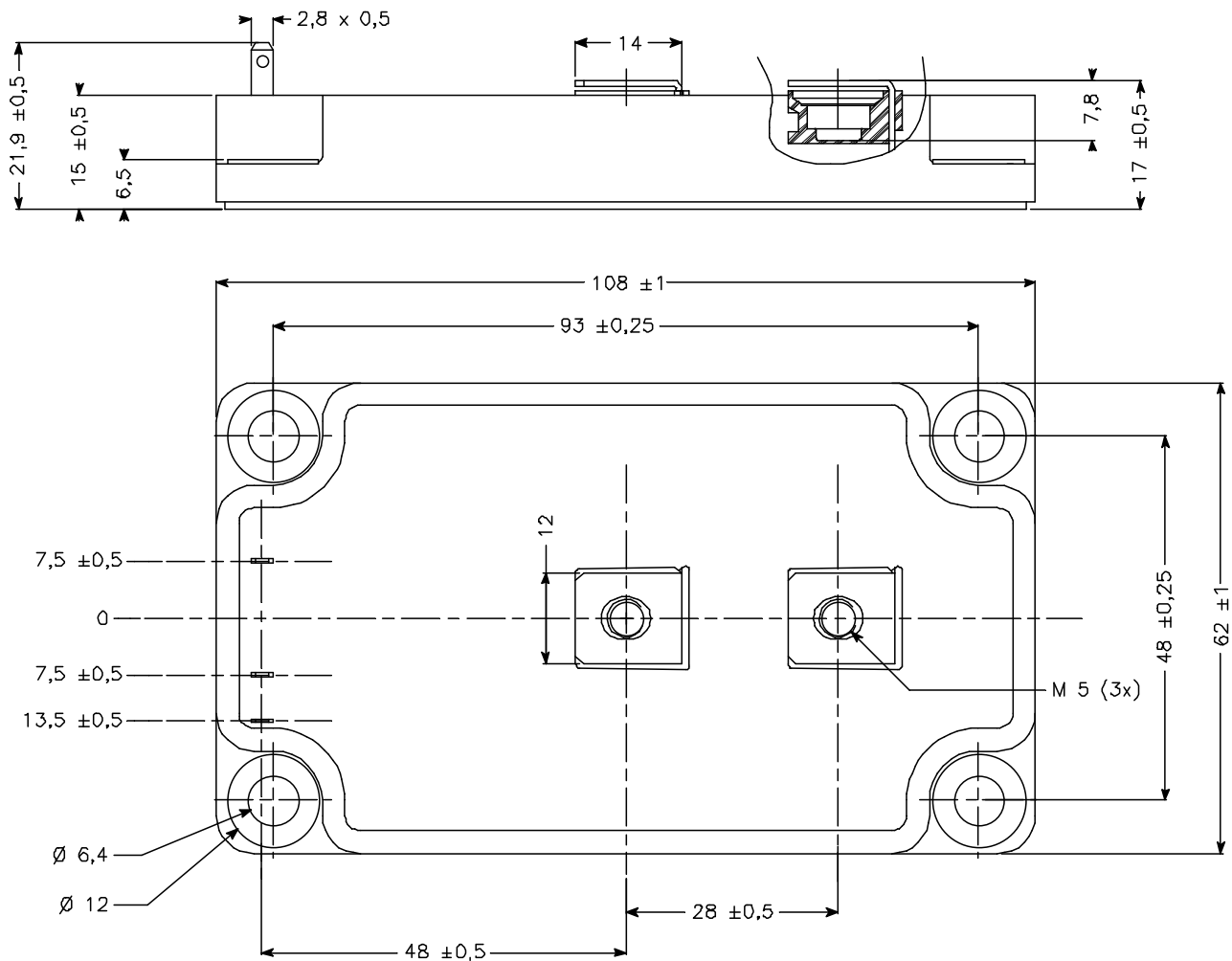

See application note APT0601 - Mounting Instructions for SP6 Power Modules on [www.microsemi.com](http://www.microsemi.com)

## Typical Performance Curve

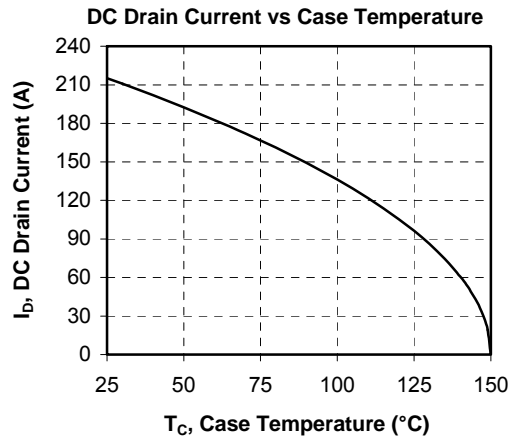
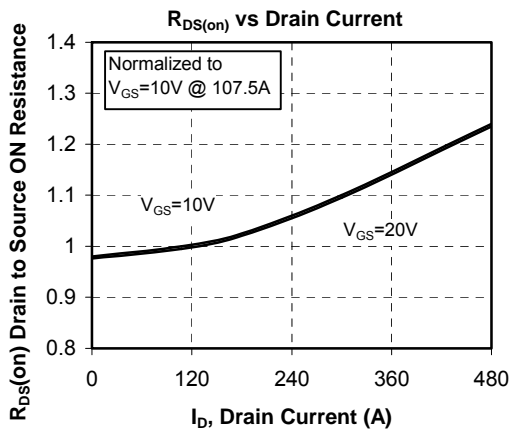
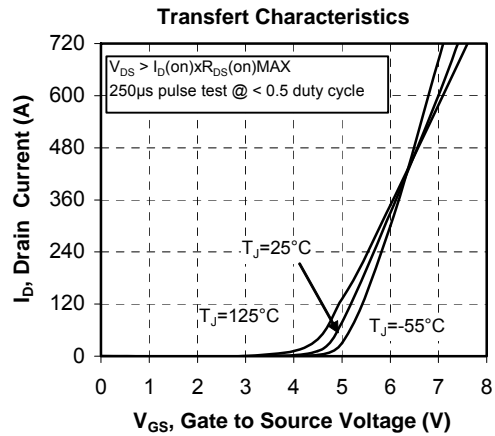
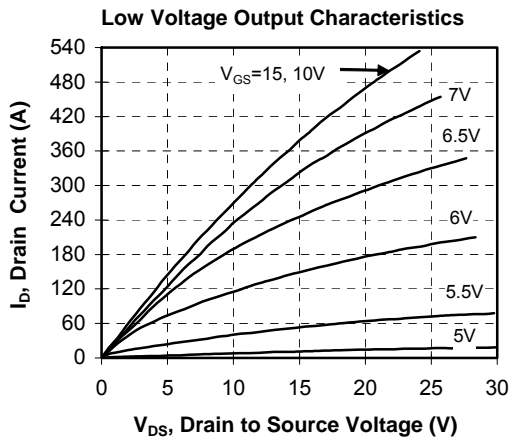
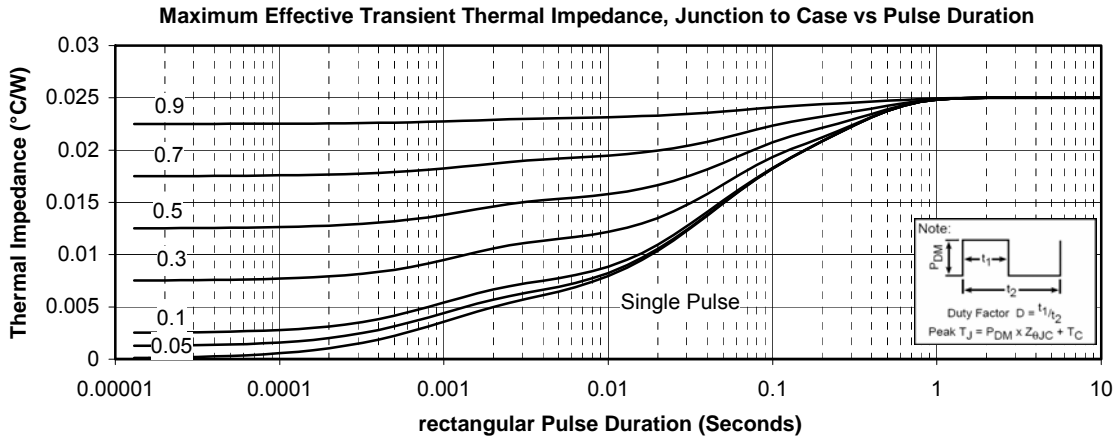

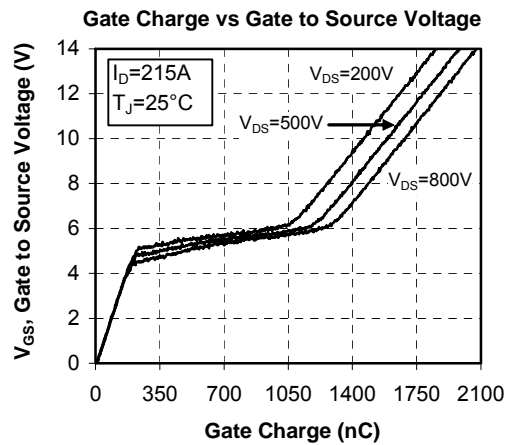
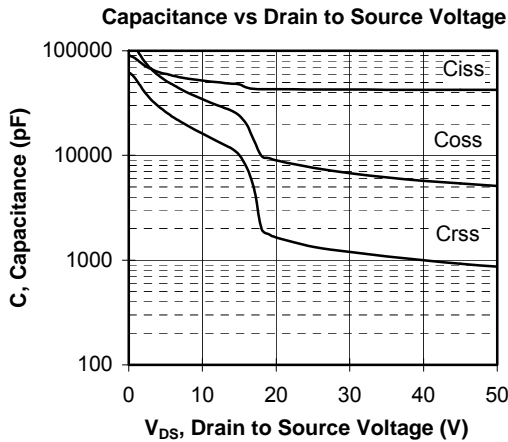
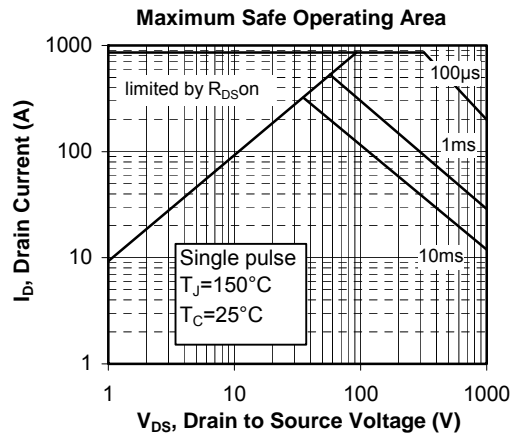
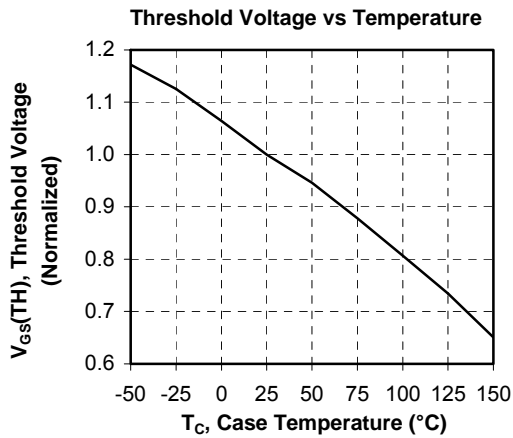
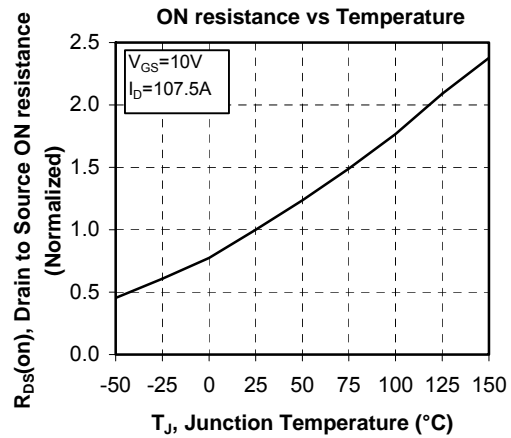
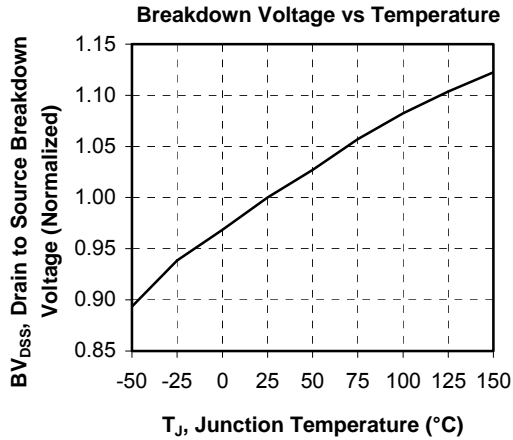

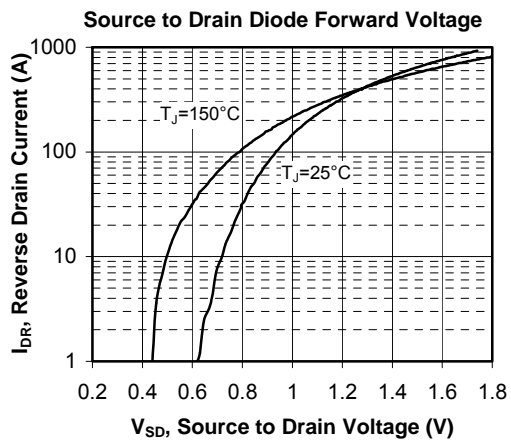
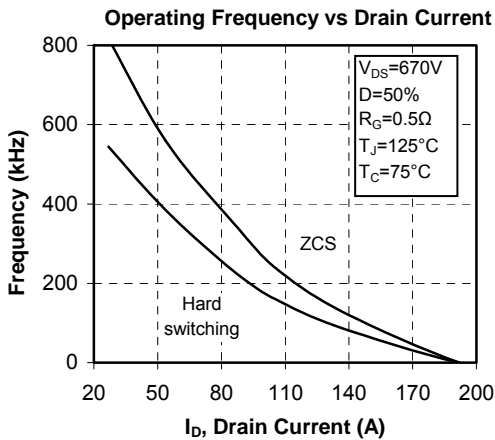
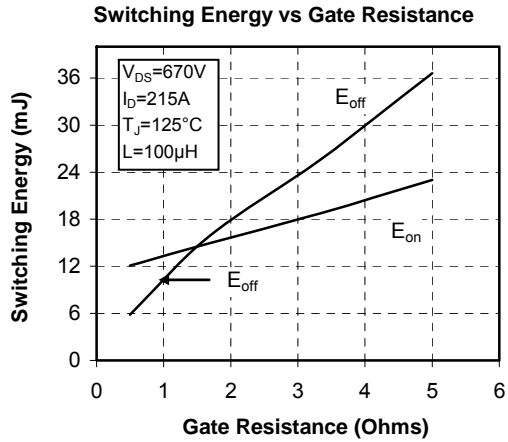
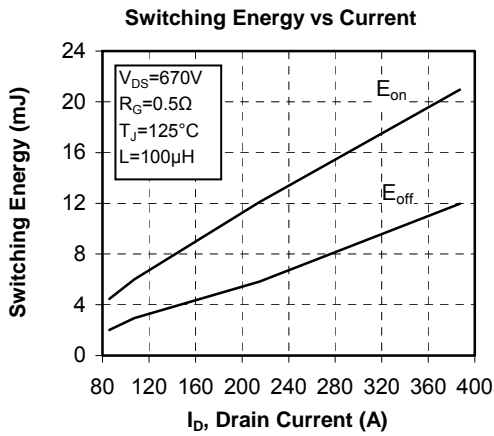
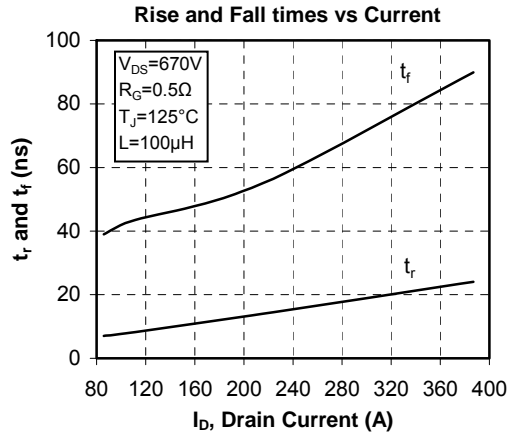
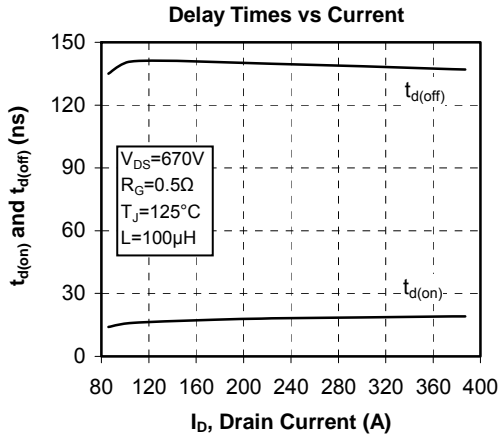

Microsemi reserves the right to change, without notice, the specifications and information contained herein

Microsemi's products are covered by one or more of U.S. patents 4,895,810 5,045,903 5,089,434 5,182,234 5,019,522 5,262,336 6,503,786 5,256,583 4,748,103 5,283,202 5,231,474 5,434,095 5,528,058 and foreign patents. U.S. and Foreign patents pending. All Rights Reserved.